

XXIX. *An Account of some Experiments to measure the Velocity of Electricity and the Duration of Electric Light.* By CHARLES WHEATSTONE, Esq. Professor of Experimental Philosophy in King's College, London. Communicated by MICHAEL FARADAY, Esq. F.R.S. &c.

Received and Read June 19, 1834.

§ 1.

THE path of a luminous or an illuminated point in rapid motion, it is well known, appears as a continuous line, in consequence of the after duration of the visual impression. There is nothing, however, in the appearance of such a line by which the eye can determine either the direction or the velocity of the motion which generates it. It occurred to me some years since, that if the motion which described the line in these cases were to be compounded with another motion, the direction and velocity of which were known, it would be easy, from an inspection of the resultant straight or curved line, to determine the velocity and direction of the former. Following up this idea, I made a series of experiments relating to the oscillatory motions of sonorous bodies, too numerous, and not sufficiently connected with the subject of the present communication, to be detailed in this place. The satisfactory results thus obtained made me desirous to ascertain whether, by similar means, some information might not be gained respecting the direction and velocity of the electric spark: the method by which I then proposed to effect this purpose was first announced in a lecture delivered by Dr. FARADAY at the Royal Institution in June, 1830. My attention was again drawn to the subject at the commencement of last year, and I attempted to realize the idea in the following manner.

Fig. 1 represents the apparatus employed, which was screwed at *a* to the spindle of a whirling machine, so that a rapid rotatory motion might be given to it. The upper and lower parts, which were all of brass except the wooden disc *b c*, were insulated from each other by a stout glass rod *d e*; a slip of tinfoil connected the ball *h* with *a*, and the upper ball *g* was capable of adjustment to various distances from the lower one *h*. When the ball *f* was placed within striking distance of the prime conductor of an electric machine, a spark passed between them, and also between the balls *g* and *h*, which could be separated to the distance of four inches, so as to exhibit a spark of that length. It is obvious, that if the angular motion of the balls were in any sensible proportion to the velocity of electricity, there would be a deviation between the upper and lower terminations of the line. The instrument revolving from left to right, if

4 F 2

the motion of the spark be downwards, the deflection of the line should be as in fig. 2; and if its motion be upwards, it should be deflected as in fig. 3.‡

When the apparatus was made to revolve rapidly, the sparks passed in the same manner as when it was at rest, and no deviation of the extremities of either of the two sparks from the same vertical line was observed. The apparatus revolved fifty times in a second, and as a difference of the twentieth part of the circumference described by the balls could have easily been observed had it existed, we may safely conclude that the spark passed jointly through the air and the metallic conductor in less time than the thousandth part of a second.

§ 2.

Having failed to observe any deflection of the spark by the means just mentioned, I found it necessary, if I would continue the inquiry, to contrive some more effectual means of prosecuting it. It occurred to me that the motion of the reflected image of the electric spark in a plane mirror would answer all the purposes of the motion of the apparatus itself connected with the spark. Several advantages, it was evident, would result from this substitution; the apparent motion of the reflected image in a small moving mirror would be equal to an extensive motion of the object itself; the same mirror might be presented to any object to be examined, thus forming, with its moving machine, an independent and universally applicable instrument; and many experiments might be tried, which, without this expedient, would be difficult or impossible to perform, from the size or immobility of the apparatus.

The most convenient form of the revolving mirror is represented in fig. 4; it rotates on a vertical axis, and in its motion successively assumes every vertical plane. If a luminous point, the flame of a candle for instance, be placed at any distance before this revolving mirror, the successive places of its reflected image will describe a circle, the radius of which is equal to the perpendicular distance between the luminous point and the axis of rotation. The angular velocity of the image is twice that of the mirror; the entire circle is consequently described while the mirror makes a semi-revolution; and if the back of the mirror be also a reflecting surface, the image will describe two entire circles during one revolution of the mirror. If the motion exceed a certain rapidity, the successive images leave their impressions on the retina, and the eye, properly placed, takes in the view of a perfectly continuous line of light, being an arc of the circle described, which arc is larger in extent in proportion to the proximity of the eye to the mirror.

If now, while the mirror is in motion, the luminous point be moved in a direction parallel to the axis of rotation, the composition of the two motions of the image, the one depending on the motion of the object, the other on the motion of the mirror, will give rise to a diagonal resultant; and if the number of rotations made by the mirror in a given time are known, the direction and velocity of the moving point may be calculated.

By screwing the axis of the mirror to a machine with multiplying wheels, I was enabled to cause it to revolve fifty times in a second. The reflected image of a luminous point, therefore, passed over half a degree in the 72,000dth part of a second, the angular velocity of the image being, as before noticed, double that of the mirror. An arc of half a degree is easily estimated by the eye, and is equal to about an inch seen at the distance of ten feet. Supposing this to be the limit of distinct observation, though perhaps a much smaller arc might be distinguished even by the unassisted eye, we might expect, when a line of electric light is placed parallel to the axis of the revolving mirror, to ascertain two things: first, the duration of the light at each point where it appears; and secondly, the time which elapses between the appearance of the light in two successive points of its path; provided that the time, in either case, be not less than the 72,000dth part of a second. The first would be indicated by the horizontal elongation of the reflected image, and the second by the distance between two lines drawn from the images perpendicular to the horizontal plane. If the duration and velocity were both rendered sensible by the mirror, the reflected image would appear as a deflected band of light.

I successively presented to the mirror, sparks four inches in length drawn from the prime conductor of a powerful electrical machine; the explosions of a charged jar; a glass tube four feet in length, exhibiting a spiral of electric sparks passing between dots of tinfoil; an exhausted glass tube six feet in length, through which the spark passed, and produced an unbroken line of attenuated electric light; various pictures, such as birds, stars, &c., formed of electric sparks. But in all these cases, when the reflected images occurred within the field of view, they appeared perfectly unaltered, and precisely as they would have done had they been reflected from the mirror while at rest.

When sparks were made to follow each other quickly, several reflected images were simultaneously seen in different positions, owing to the images having been renewed before the visual impression caused by the first had disappeared. The exhausted tube being held near a prime conductor, when looked at directly, will sometimes appear to gleam with a continuous light; but examined in the mirror, this apparent continuity is seen to be owing to a rapid succession of transient flashes.

§ 3.

For some experiments another position of the revolving mirror is preferable to that just described. Fig. 5 represents the reflecting surface inclined to the axis of rotation, and nearly perpendicular to it. If a luminous point be placed anywhere in the prolongation of the axis, its images, successively reflected from different parts of the mirror, form together a circle, the whole circumference of which may be seen at once. In this form of the experiment the angular velocity of the image is equal to that of the mirror, and both move in the same direction; whereas in the former case the image moved with double the velocity of the mirror, and in the opposite direction. The

visual magnitude of the circle described increases with the distance of the object and inclination of the mirror. The flame of a candle presented to it appears as a broad luminous ring; the image of the sun is converted into a magnificent fiery belt, &c.

A series of minute sparks made to pass between two points, or between a point and the prime conductor of a machine, presents to the eye, from the rapidity of their succession, the appearance of a permanent star of light. When this star is placed in the prolongation of the axis of the revolving mirror, the successive sparks of which it consists are reflected to the eye each from a different part of the surface, and they are exhibited arranged at regular distances in a circle. When the intermissions are rapid the appearance is extremely beautiful.

The brush of light which appears on a point when presented at some distance from the conductor, is also by this means shown to be an intermitting action, notwithstanding its permanent appearance; its reflected images present, however, this remarkable peculiarity, they are elongated in the direction of the motion, proving that a brush is not so transient as a spark, and that the emissions which constitute it last during an interval of time measurable by the motion of the mirror.

But this instrument is not confined to observe merely the intermittences of electric light; whenever a rapid succession of alterations occurs in an object which does not change its place, they may be separately examined by this means. Vibrating bodies afford many instances for investigation; one among these is perhaps worthy to be mentioned. A flame of hydrogen gas burning in the open air presents a continuous circle in the mirror; but while producing a sound within a glass tube, regular intermissions of intensity are observed, which present a chain-like appearance, and indicate alternate contractions and dilatations of the flame corresponding with the sonorous vibrations of the column of air.

§ 4.

Experiments have frequently been made with a view to determine the velocity of the transmission of electricity through conducting bodies. In all the recorded trials of this kind it was attempted to measure the interval of time supposed to occur between two discharges made at opposite extremities of the wire, which were brought near each other so that they might be seen at the same time. In one experiment, performed at Shooter's Hill in 1747 under the superintendence of Dr. WATSON, the circuit was four miles in extent, two miles through wire, and two miles through the ground; but the discharges appeared, as in all similar experiments, to be perfectly simultaneous. Nor need we feel surprised at this result, when we know that the eye is unable to distinguish the succession of luminous objects which follow at the interval of the eighth or tenth of a second, from their simultaneous appearance; and that, therefore, with a circuit even of four miles extent, the velocity of a few miles per second would be the utmost observable by such means.

I determined, therefore, to repeat a similar experiment, substituting for the im-

perfect judgement of the eye a revolving mirror, but more rapid in its motion and accurate in its indications than any I had previously employed. The instrument I am about to describe will, unless there be some error in the estimate which I have not been able to perceive, measure beyond the millionth of a second; and this degree of minuteness may be yet far surpassed by more costly instruments and more careful observations.

But as it is only on the hypothesis of an actual transfer of a fluid from one end of the wire to the other that a difference of time between the two sparks at its opposite extremities might be expected to be observed, in order to render the proposed experiment independent of this theoretical view, I took the necessary precaution of bringing a third spark, formed by disconnecting the middle of the wire, near to and in a line with the extreme sparks. For on the supposition of the transfer of two fluids in opposite directions, the extreme sparks would be simultaneous, but the middle spark later in its occurrence; the same appearances would also accord with the theory of one electricity, if we admit that a disturbance of electric equilibrium is simultaneously propagated from each end, arising in the one case from successive additions to, and in the other from successive subtractions from, the neutral quantity in the conducting wire.

The experiment was tried at the Gallery in Adelaide Street. The insulated wire, the total length of which was half a mile, was disposed as in fig. 6. The parallel portions of the wire were each 120 feet in length, and six inches apart, and were tied to the balustrade with silk loops six inches long. The swagging of the wire was prevented by silk cords extending across the gallery; and to keep the lengths at their proper distances apart they were tied to the cords wherever they crossed them. The ends of the wire marked 2, 3, 4, 5, were continued to the similarly marked wires of the spark-board, fig. 7, which was so fixed against the wall beneath the gallery, that the balls between which the sparks were to pass were in the same horizontal line. The striking-distance between each spark was the tenth of an inch, and the spark-board itself was three inches and a half in diameter. The conducting wire I employed was of copper, and its thickness the fifteenth of an inch.

Fig. 8. represents the measuring instrument with its appendages; and fig. 10. shows in a more distinct manner some of its essential parts. A B C D is a solid board of well baked mahogany one foot in length, and eight inches in breadth. E is a circular mirror of polished steel one inch in diameter, so fixed to the horizontal axle F G, that the axis of rotation is in the plane of the mirror. The pivots of the axle work in the uprights of the brass frame H I. Motion is communicated from the wheel K to the axle by means of a thread passing over grooves made on the circumferences of both; and a band passing over the wheel L, on the same axis with K, may be attached to the wheel of any machine capable of giving to it a rapid motion. In the experiments I have made with this instrument the train of wheels was so arranged that the axle carrying the mirror would have made 1800 revolutions

while the wheel to which the motion was first communicated was turned round once, had there been no retardation to have been taken into consideration arising from the slipping of the bands. M is a small Leyden jar, the inner coating of which is to be constantly supplied, through the chain N, with electricity, either positive or negative, from a machine; the bent wire proceeding from the inner coating of the jar is in immediate contact with the fixed discharger O P, and the spontaneous discharge of the jar is to be regulated by varying the distance between the two balls. The wire 1 in connexion with the outer coating of the jar, and the wire 6 attached to the knob of the brass frame, are continued to the similarly numbered wires of the spark-board. When the jar is fully charged, and the arm Q, revolving with the axle, is brought opposite the knob of the discharger, the discharge of electricity, or disturbance of electric equilibrium, passes through the entire circuit, and the three sparks appear perfectly simultaneous to the eye. When the face of the mirror is level with and turned towards the spark-board, and is so adjusted as to form an angle of 45° with the horizontal plane, the eye looking directly downwards sees the reflected images of the three sparks. The plane glass or lens R is for the purpose of preventing the eye approaching too near the mirror, and for accommodating the vision of long- or short-sighted observers. The arm Q is so placed that the circuit may be completed when the mirror is in the position just described; the other arm serves merely as a counterpoise. To obviate the inaccuracy which would result from discharges taking place when the arm is in different positions with respect to the knob of the discharger, a plate of mica, S, is interposed, having a very small horizontal slit exactly opposite the axis of the discharger; this fixes within narrow limits the occurrence of the discharge, and, with whatever rapidity the mirror moves, the sparks are generally within the field of view.

It was a point of essential importance to determine the angular velocity of the axle carrying the mirror. No confidence could be placed in the result obtained by calculating the train of wheels, as in such rapid motion many retarding causes might operate and render the calculation uncertain: it was necessary, therefore, to devise a means independent of these sources of error, and which should immediately indicate the ultimate velocity. Nothing appeared more likely to effect this purpose than to attach a small syren to the instrument, the plate of which should be carried round by the axle of the mirror. T is a small hollow box an inch in diameter, into which wind was conveyed through a tube placed to the aperture *u*. On the face of this box a number of equidistant apertures were arranged in a circle, and a disc moving before it having the same number of apertures, periodically intercepted the issuing current, and produced a sound corresponding to the frequency of the impulses. It is obvious that the number of revolutions would be ascertained by dividing the number of vibrations in a second, corresponding to the sound, by the number of apertures. I at first employed ten apertures: when the motion was slow, the sound could be easily determined; but on augmenting the velocity it became inappreciable. I then

reduced the number of apertures to five, but with no better success, and ultimately to two; but the sound was then so feeble, compared with the accompanying noises, that it could not be distinctly heard.

The difficulty was at last overcome by employing the arm Q itself to produce the sound. A small slip of paper was held to it; and as at every revolution a blow was given to the paper, its rapid recurrence gave rise to a sound the pitch of which varied with the velocity of the motion. When the machinery was put in motion with the maximum velocity I employed in my experiments, the sound G \sharp^4 was obtained, indicating 800 revolutions of the mirror in a second. I am not aware that anything can have interfered with the accuracy of this result; the same sound was heard when different pieces of paper or card were used; and on moderating the velocity, the sound descended through all the degrees of the scale below it, until distinct percussions were perceived*.

Let us now consider what is the shortest duration of the electric light, and the greatest velocity of transmission through the wire, that can be detected by means of the instrument I have described. The mirror revolves 800 times in a second; and during this time the image of a stationary point would describe 1600 circles: the elongation of a spark through half a degree, a quantity obviously visible, and equal to one inch seen at the distance of ten feet, would therefore indicate that it exists the 1,152,000th part of a second. The deviation of half a degree between the two extreme sparks, the wire being, as above stated, half a mile in length, would indicate a velocity of 576,000 miles in a second. This estimated velocity is on the supposition that the electricity passes from one end of the wire to the other: if, however, the two fluids in one theory, or the disturbances of equilibrium in the other, travel simultaneously from the two ends of the wire, the two external sparks will keep their relative positions, the middle one will be alone deflected, and the velocity measured will be only half that in the former case, viz. 288,000 miles in a second.

Repeated experiments gave the following results. In all cases, when the velocity of the mirror exceeded a certain limit, the three sparks were elongated into three parallel lines, and the lengths became greater as the velocity of the motion was increased. The greatest elongation observed was about 24° , indicating a duration of about the 24,000th of a second. The lines did not always commence at the same places; sometimes they appeared immediately below the eye, sometimes to the right, at other times to the left, and occasionally they were out of view altogether. This indetermination, it has already been explained, is owing to the arm not always taking the spark at the same distance from the discharger: several discharges are therefore required to be made before the eye can distinctly observe the appearances. When

* Since this paper was read, a registering apparatus has been attached to the instrument; it consists of an index, communicating with the axis by a light train of wheels, and making one complete revolution while the mirror revolves 10,000 times. The number of revolutions of the mirror indicated by this means, did not, in consequence of the increased resistance to the motion, exceed 600 in a second.

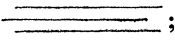
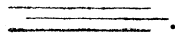
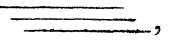
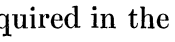
the velocity was low, the terminating points appeared to be exactly in the same vertical line; but when the velocity was considerable, and the mirror revolved towards the right, the lines assumed this appearance, ; when it revolved towards the left, they appeared thus, . In no case did I see them thus, , or thus, , as required in the hypothesis of the actual transfer of a single fluid. I found it convenient to place at the side of and near the spark-board, the flame of a taper or candle, to serve as a guide to the eye: the lines of electric light in the mirror were immediately above and parallel to the constant line formed by the reflection of this flame, and thus the eye could be more readily directed to them: it also served to keep the focal distance of the eye properly adjusted. The spark-board was in all the experiments placed at the distance of ten feet from the mirror.

The deviation between the extreme sparks and the middle one could not, I am tolerably certain, have exceeded half a degree.

Having obtained a considerable elongation of these sparks, I expected also to be able to elongate the sparks or widen the lines in some of the various arrangements of electric light described in § 2; but even with the extraordinary velocity now attained, no alteration whatever could be observed in them; they were still reflected as distinct and unaltered as the objects themselves when directly looked at. The elongation of the sparks at the interruptions of the wire above noticed were no doubt owing to this circumstance,—that the diameter of the wire was not sufficiently great to allow the charge of the jar to pass through it except in a successive manner. The duration of the discharge in the cases of these sparks appeared to be longer than the time required for the electricity to pass through many miles of wire.

The sparks from the great magnet constructed by Mr. SAXTON, which is at the Gallery in Adelaide-street, were considerably elongated even when the mirror was moving with a comparatively low velocity.

§ 5.

For the purpose of increasing the chances of observing sparks, &c., when their appearance cannot be commanded at the moment the mirror is in the proper position to reflect them to the eye, I propose to employ a mirror with polygonal faces symmetrically placed with respect to the axis of rotation, a hexagon for instance, fig. 9, where a, b is the moving axis, and c, d, e three of the reflecting surfaces. During one rotation of the axis, if the object be continuously luminous, six luminous arcs will be successively presented to the eye, all occupying the same position; and if the light be transient, we shall have six times the number of chances of observing its reflection than if one reflecting surface only were employed. It is true the arcs are not circular ones, but the difference is scarcely noticeable when the radius of the polygonal section is very small compared with the distance of the luminous object, which would be the case in all our experiments.

Fig. 7.

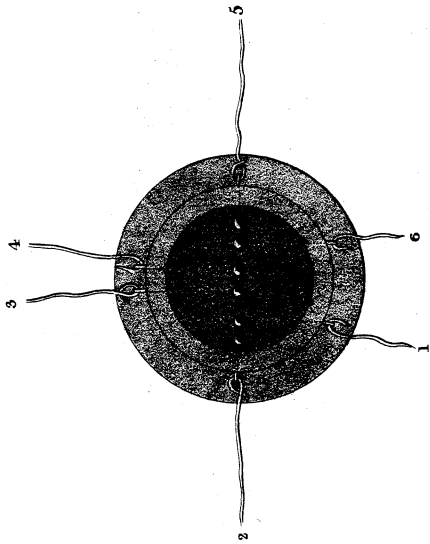

Fig. 10.

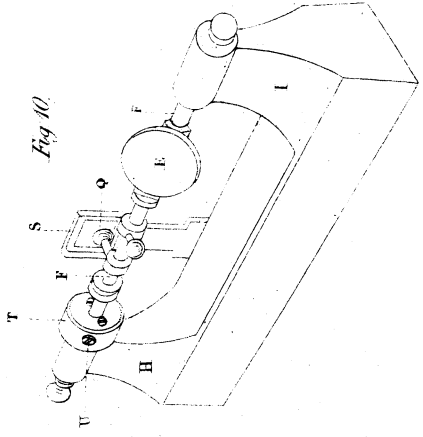
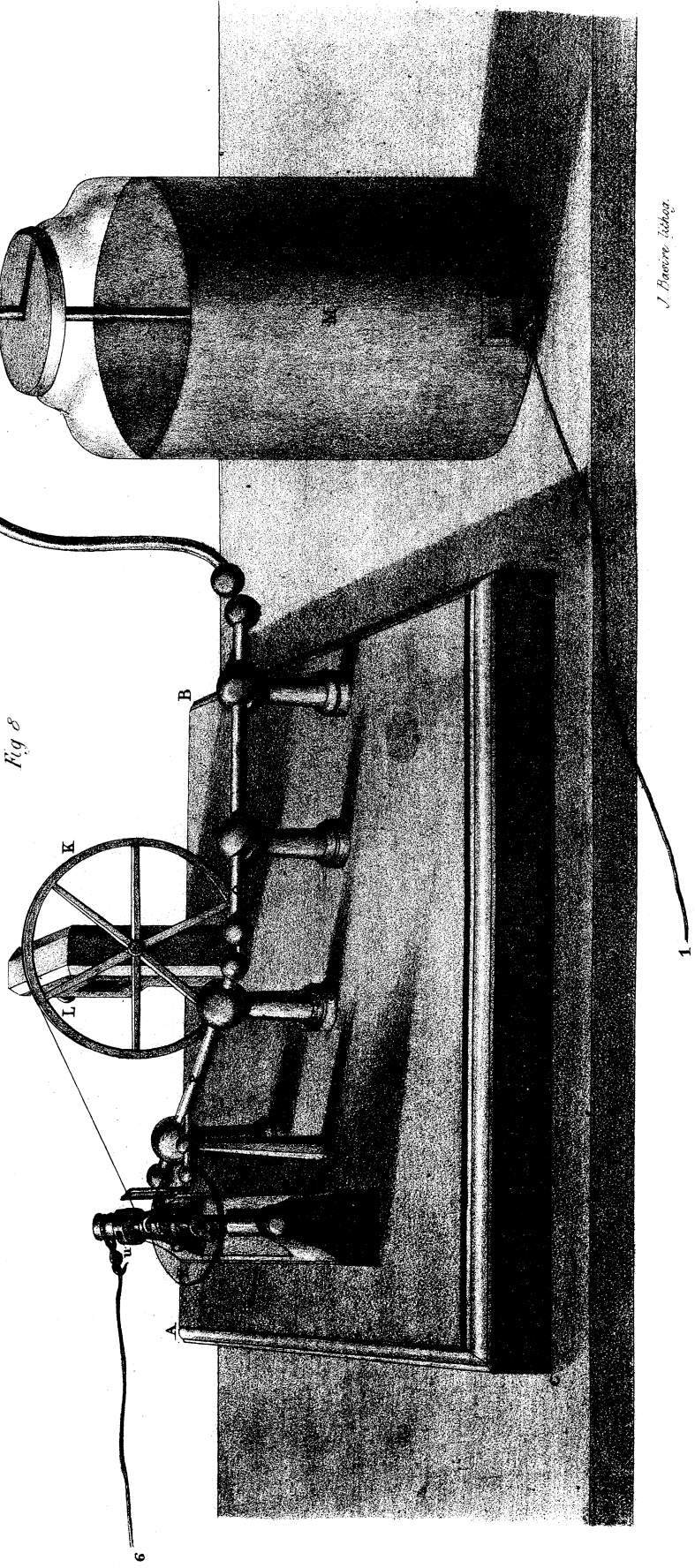

Fig. 8.



J. Pascoe delin.

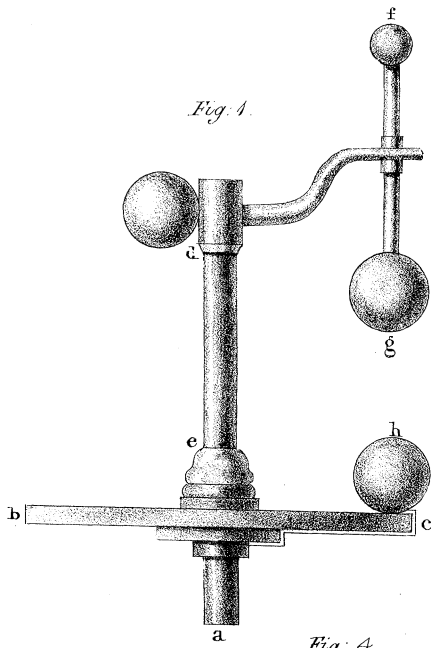

Fig. 1.



Fig. 2.



Fig. 3.

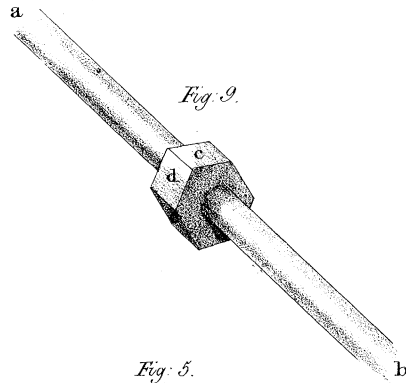

Fig. 4.

Fig. 4.

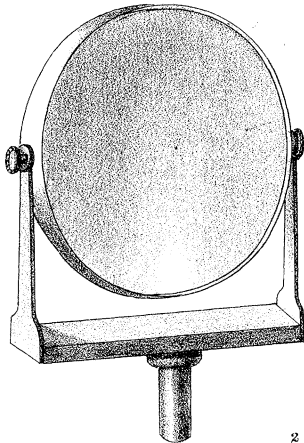

Fig. 5.

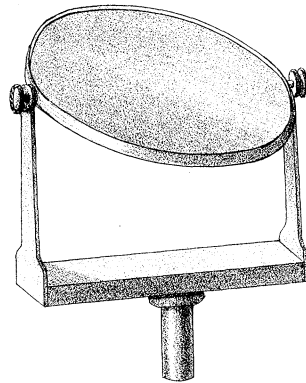
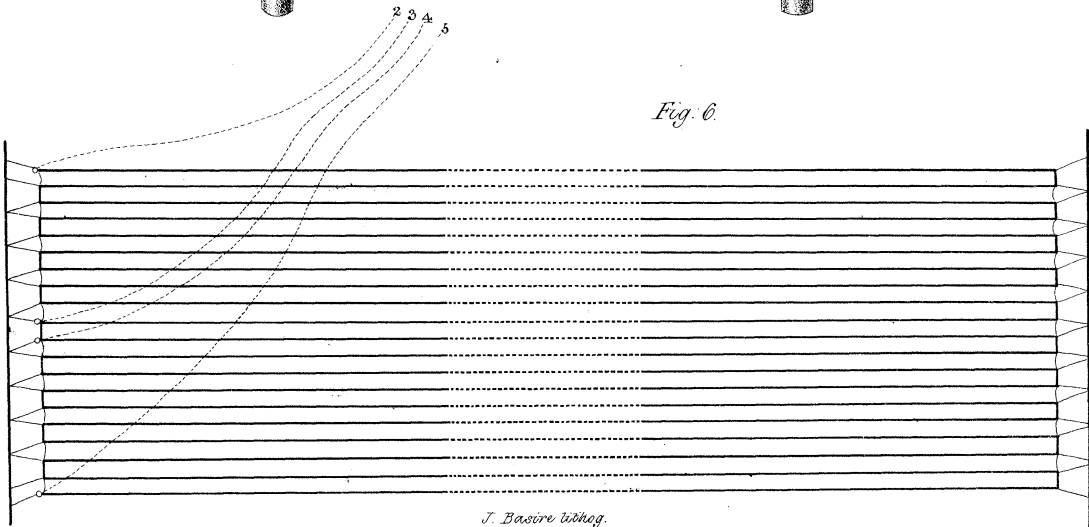

Fig. 6.



J. Basire lithog.

I have also proposed various modifications of parts of the instrument, § 4, to suit particular experiments, and to ensure additional accuracy in the repetition of those already made; but not having yet put these to the test of experiment, it would be premature at present to describe them.

§ 6.

The instantaneousness of the light of electricity of high tension, rendered evident by the preceding investigations, affords the means of observing rapidly changing phenomena during a single instant of their continued action, and of making a variety of experiments relating to the motions of bodies when their successive positions follow each other too quickly to be seen under ordinary circumstances.

A few obvious instances will at present suffice. A rapidly moving wheel, or a revolving disc on which any object is painted, seems perfectly stationary when illuminated by the explosion of a charged jar. Insects on the wing appear, by the same means, fixed in the air. Vibrating strings are seen at rest in their deflected positions. A rapid succession of drops of water, appearing to the eye a continuous stream, is seen to be what it really is, not what it ordinarily appears to be, &c.

§ 7.

The preceding experiments having been directed rather to detect elongations and deviations than to measure them, I am not prepared to state the results with numerical accuracy. I shall endeavour to supply this deficiency in further investigations, but must at present content myself with stating the following general conclusions, deduced from the appearances which I have observed, though, I must allow, more accurately performed experiments are required before they can be considered as fully established. 1st, The velocity of electricity through a copper wire exceeds that of light through the planetary space. 2ndly, The disturbance of electric equilibrium in a wire communicating at its extremities with the two coatings of a charged jar, travels with equal velocity from the two ends of the wire, and occurs latest in the middle of the circuit. 3rdly, The light of electricity in a state of high tension has a less duration than the millionth part of a second. 4thly, The eye is capable of perceiving objects distinctly, which are presented to it during the same small interval of time.

By prosecuting these researches with instruments of higher power, and of greater accuracy in their indications, numerical laws may be established for a large class of phenomena, the relations of which we have had hitherto no means of observing. The relative velocities of electricity in different metallic wires; the modifications in the velocity of electricity in different states of tension when passing through the same conductor, if any such differences exist; the duration of the electric spark under different circumstances of tension and quantity, &c., will be among these objects of investigation.